

PRODUCT DATASHEET

Model: L2T725 L3T725 L4T725

Category: LED Tracklight

Description: 17W LED Tracklight



General Information

Material: Aluminum

Fitting Colors: Matte White/ Black

Rotation Angle (degree): 355

Tilting Angle (degree): 90

Track System: Available in single wire, 3 wire, 3 phase

IP Rating: 20

Working Temperature (°C): -5- +35

Storage Temperature (°C): -20 - +50



Product Dimensions and Cut-out Information

Fitting Length (mm): Not Applicable

Diameter (mm): 65

Height (mm): 167

Cut-out Dimension (mm): Not Applicable

Dimension:

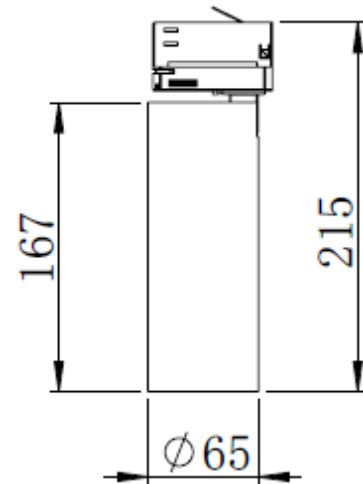

Packing Information

Packaging Type: Individual box

Quantity per carton: 20

CBM per carton: 0.0379

Lifespan

Lifetime (hours): 50000

PRODUCT DATASHEET

Model: L2T725 L3T725 L4T725

Category: LED Tracklight

Description: 17W LED Tracklight



Light Technical Information

Color Temperature	CRI (Ra)	Gamut Index (GAI)	System Lumen	Lumen per Watt
2700	90	90	1426	71
2700	95	100	1232	62
3000	90	90	1488	74
3000	95	100	1284	64
4000	90	90	1564	78
4000	95	100	1417	71
5000	90	90	1635	82
5000	95	100	1412	71

LED Manufacturer: Luminus

LED Type: COB

LED Model: CXM-9 Gen 4

Optic: Reflector

Beam Angle (°): 17/25/38/55

Electrical Information

System Power (w): 20

Input Voltage (v) & Frequency: 220-240V 50/60Hz

Output Voltage (v): 31-37

Current (mA): 500

Driver: Rio Non-dimmable driver

Power Factor: 0.9

Efficiency (%): 90

Total Harmonic Distortion (%): <25

Ripple (%): ±1

Dimmable: Triac Dimming – Upon Request

1-10V Dimming – Upon Request

Dali Dimming – Upon Request