

PRODUCT DATASHEET

Model: LDL451

Category: LED Downlight

Description: 23w LED Downlight



General Information

Material: Aluminium

Fitting Colors: White/ Black/ Painted Silver

Rotation Angle (degree): Not Applicable

Tilting Angle (degree): Not Applicable

Track System: Not Applicable

IP Rating: Not Applicable

Working Temperature (°C): -5 - +35

Storage Temperature (°C): -20 - +50



Product Dimensions and Cut-out Information

Fitting Length (mm): Not Applicable

Diameter (mm): 163

Height (mm): 147

Cut-out Dimension (mm): 150

Packing Information

Packaging Type: Individual box

Quantity per carton: 6

CBM per carton: 0.0768

Gross weight per carton (kgs): 10.7

Lifespan

Lifetime (hours): 30000

Luminous Flux after 50000hours (lm): LM80 Comply

Dimension:

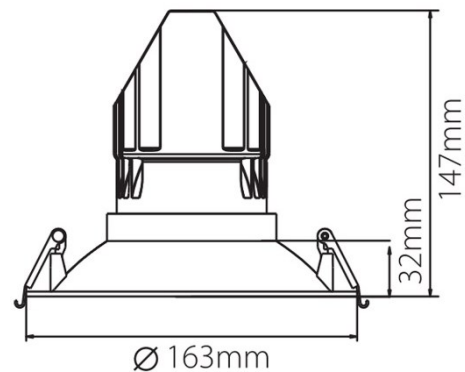

PRODUCT DATASHEET

Model: LDL451

Category: LED Downlight

Description: 23w LED Downlight



Light Technical Information

Color Temperature	CRI (Ra)	Gamut Index (GAI)	System Lumen	Lumen per Watt
2700	90	90	2420	93
2700	95	100	2316	89
3000	90	90	2613	100
3000	95	100	2437	94
3000 Vivid White	90	110	2481	95
4000	95	100	2414	93
5000	80	90	Not Applicable	Not Applicable
5000	90	90	2825	109

LED Manufacturer: Luminus

LED Type: COB

LED Model: CXM-18 Gen 3

Optic: Reflector

Beam Angle (°): 17/24/40/60

Electrical Information

System Power (w): 26

Input Voltage (v) & Frequency: 220-240V 50/60Hz

Output Voltage (v): 31-37

Current (mA): 700

Non-Dimmable: Rio Non-Dimmable Driver

Power Factor: 0.9

Efficiency (%): 76

Total Harmonic Distortion (%): <30

Ripple (%) :Not Applicable

Dimmable: Triac Dimming – Upon Request

1-10V Dimming – Upon Request

Dali Dimming – Upon Request