

PRODUCT DATASHEET

Model: LDG902

Category: LED Adjustable Downlight

Description: 17w LED Adjustable Downlight



General Information

Material: Aluminium

Fitting Colors: White/ Black/ Painted Silver

Rotation Angle (degree): Not Applicable

Tilting Angle (degree): 30

Track System: Not Applicable

IP Rating: 20

Working Temperature (°C): -5 - +35

Storage Temperature (°C): -20 - +50



Product Dimensions and Cut-out Information

Fitting Length (mm): Not Applicable

Diameter (mm): 178 x 118

Height (mm): 128

Cut-out Dimension (mm): 120 x 120

Dimension:

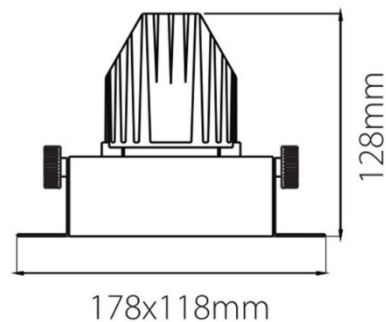

Packing Information

Packaging Type: Individual box

Quantity per carton: 12

CBM per carton: 0.0570

Gross weight per carton (kgs): 16.8

Lifespan

Lifetime (hours): 50000

Luminous Flux after 50000hours (lm): LM80 Comply

PRODUCT DATASHEET

Model: LDG902

Category: LED Adjustable Downlight

Description: 17w LED Adjustable Downlight



Light Technical Information

Color Temperature	CRI (Ra)	Gamut Index (GAI)	System Lumen	Lumen per Watt
2700	90	90	1710	90
2700	95	100	1634	86
3000	90	90	1844	97
3000	95	100	1722	91
3000 Vivid White	90	110	1753	92
4000	95	100	1837	97
5000	80	90	Not Applicable	Not Applicable
5000	90	90	1993	105

LED Manufacturer: Luminus

LED Type: COB

LED Model: CXM-14 Gen 3

Optic: Reflector

Beam Angle (°): 17/24/40/60

Electrical Information

System Power (w): 19

Input Voltage (v) & Frequency: 220-240V 50/60Hz

Output Voltage (v): 31-37

Current (mA): 500