

PRODUCT DATASHEET

Model: LDG812

Category: LED Adjustable Downlight

Description: 31w LED Adjustable Downlight



General Information

Material: Aluminium

Fitting Colors: White/ Black/ Painted Silver

Rotation Angle (degree): Not Applicable

Tilting Angle (degree): 30

Track System: Not Applicable

IP Rating: 20

Working Temperature (°C): -5 - +35

Storage Temperature (°C): -20 - +50



Product Dimensions and Cut-out Information

Fitting Length (mm): Not Applicable

Diameter (mm): 257 x 140

Height (mm): 119

Cut-out Dimension (mm): 240 x 130

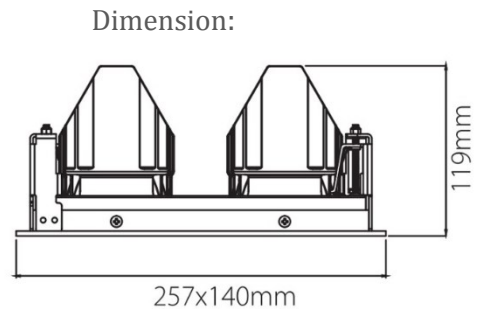

Packing Information

Packaging Type: Individual box

Quantity per carton: 6

CBM per carton: 0.0483

Gross weight per carton (kgs): 13

Lifespan

Lifetime (hours): 50000

Luminous Flux after 50000hours (lm): LM80 Comply

PRODUCT DATASHEET

Model: LDG812

Category: LED Adjustable Downlight

Description: 31w LED Adjustable Downlight



Light Technical Information

Color Temperature	CRI (Ra)	Gamut Index (GAI)	System Lumen	Lumen per Watt
2700	90	90	2914	83
2700	95	100	2784	80
3000	90	90	3142	90
3000	95	100	2934	84
3000 Vivid White	90	110	2986	85
4000	95	100	3131	89
5000	80	90	Not Applicable	Not Applicable
5000	90	90	3396	97

LED Manufacturer: Luminus

LED Type: COB

LED Model: CXM-14 Gen 3

Optic: Reflector

Beam Angle (°): 17/24/40/60

Electrical Information

System Power (w): 35

Input Voltage (v) & Frequency: 220-240V 50/60Hz

Output Voltage (v): 31-37

Current (mA): 900

Non-Dimmable: LC 40W 900mA fixC SC ADV

Power Factor: 0.95

Efficiency (%): 89

Total Harmonic Distortion (%): <20

Ripple (%): ±5

Dimmable: Triac Dimming – Upon Request

1-10V Dimming – Upon Request

Dali Dimming – Upon Request